

# **Holley®** **SNIPER EFI 2**

## **QUICKSTART MANUAL** **SNIPER 2 EFI INSTALLATION INSTRUCTIONS**



Congratulations on your purchase of a new Sniper 2 EFI Throttle Body System built by craftsmen to exact standards in our Bowling Green, Kentucky facility. Every Sniper 2 EFI System is extensively tested for functionality before it leaves our facility for “bolt on and go” performance. Each throttle body is serialized ensuring a higher standard of quality control.

Should you experience any problems or need parts assistance that this QuickStart manual or the complete installation manual does not address, contact our technical service department at 1-866-464-6553 or log on to the website for a database of technical information and online support.

For complete technical resources regarding  
Sniper 2 EFI Ecosystem, please visit:

<https://www.holley.com/sniper2tech>



Scan with  
Smart Phone

# TABLE OF CONTENTS

INTRODUCTION & SYSTEM REQUIREMENTS.....	2
MECHANICAL INSTALLATION INSTRUCTIONS.....	4
SNIPER 2 EFI WIRING COMPONENT OVERVIEW.....	6
SNIPER 2 EFI WIRING INSTRUCTIONS.....	8
INITIAL POWER-UP & WIZARD.....	12
FIRST DRIVE.....	17
SYSTEM INSTALLATION OVERVIEWS.....	18
DIAGRAM 1: SNIPER 2 EFI COIL MINUS (-) [ NO TIMING CONTROL ].....	18
DIAGRAM 2: SNIPER 2 ECO SYSTEM USING A SNIPER EFI PDM.....	19
DIAGRAM 3: SNIPER 2 ECO SYSTEM WITHOUT USING A SNIPER EFI PDM.....	20

## INTRODUCTION & SYSTEM REQUIREMENTS

Holley Performance Products has written this manual for the installation of the **Sniper 2 EFI** TBI fuel injection system. This basic manual contains the information necessary for the installation of the throttle body, wiring, and sensors. Please read all the **WARNINGS!** and **NOTES**, as they contain valuable information that can save you time and money. It is our intent to provide the best possible products for our customer; products that perform properly and satisfy your expectations.

### ENGINE REQUIREMENTS

Before moving forward with the installation, please verify your vehicle meets the engine and fuel system requirements below:

- Engine is in sound mechanical condition
- Engine horsepower is between 200-650
- Engine is a 4, 6 or 8 cylinder
- Engine has a 4 barrel, 4150 style flange intake manifold\*
- Unleaded fuel only
- Any RTV silicone sealants used on the engine are sensor safe

\* Any 4150 flange intake manifold will work. Make sure to use included gasket to seal the throttle body to the intake manifold and ensure that there are no vacuum leaks.

### FUEL SYSTEM REQUIREMENTS

The Sniper 2 EFI system requires a high pressure fuel pump capable of operating at 60 psi. When selecting a pump and lines, be sure each component is designed to perform at high pressure. Holley offers a variety of fuel pumps, hoses and accessories to complete your installation. For best results, Holley strongly recommends an in-tank pump. Installing the fuel pump in the tank results in quieter operation, less chance of cavitation and a reduction in pump temperature. If mounting the pump in the tank is not an option, install the pump as close as possible to the tank, within 2-feet of fuel tank feed is recommended. Once the fuel system is installed, checking the fuel pressure at the regulator is recommended.

Holley offers Sniper 2 EFI kits that include a complete fuel system, eliminating the hassle of selecting individual fuel system components.

### TOOLS REQUIRED FOR INSTALLATION

- |   |  |  |
|---|--|--|
| <ul style="list-style-type: none"><li>• Standard Wrench Set</li><li>• Medium Blade Screwdriver</li><li>• Drill and Assorted Bit Sizes</li><li>• Factory Service Manual for your vehicle</li></ul> | <ul style="list-style-type: none"><li>• Small Blade Screwdriver</li><li>• #2 Phillips Screwdriver</li><li>• Terminal Crimping Tool</li><li>• 7/8" Drill Bit (step-bit recommended)</li></ul> | <ul style="list-style-type: none"><li>• Allen Wrench Set</li><li>• Digital Voltmeter</li></ul> |
|---|--|--|

An assistant is necessary for some installation and adjustment procedures and should be present for safety reasons.

**WARNING! Disconnect battery before proceeding with any Fuel Injection installation.**

## **SNIPER 2 EFI THROTTLE BODY HARNESS OVERVIEW**

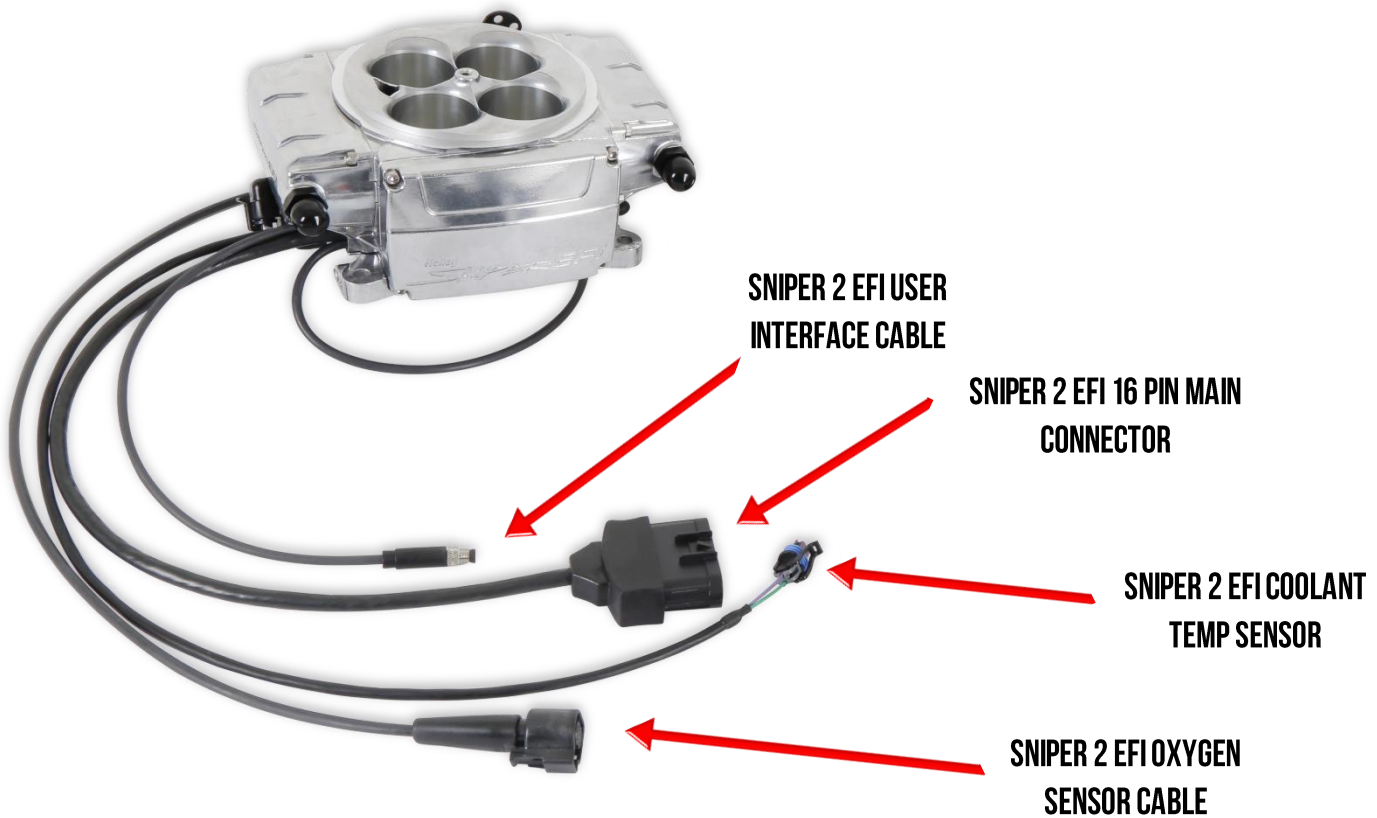

FIGURE 1

## **BEFORE YOU GET STARTED**

Holley Performance highly recommends the following items be checked and/or corrected prior to installation of your new Sniper 2 EFI system to ensure optimum performance from your engine.

Many times, a carburetor is looked at as the main cause of other engine-related difficulties that might exist. It's best to check and verify the condition of the complete engine system before proceeding with an EFI conversion. There should be no *vacuum leaks*, *the ignition timing should be properly set*, and *the engine should be in sound mechanical condition*. Converting to EFI won't fix an engine with mechanical problems. If the engine does not run correctly with a carb, there is a good chance it won't run well with EFI.

**DO NOT USE Solid Core Spark Plug Wires:** Holley recommends [MSD 8.5mm Super Conductor](#) Wires with Sniper 2 EFI

**NOTE:** Part number [520-1](#) is a complete installation kit.

**NOTE:** Sniper 2 EFI is designed to use standard Holley 4150 Transmission Kickdown & Throttle cable brackets: [20-95](#), [20-88](#), [20-93](#), [20-2](#), [20-112](#)

**Before beginning the Sniper 2 EFI installation, a switched 12v Ignition source must be identified. This source must have 12v while cranking and in the run position. Do NOT connect the switched 12v wire from the Sniper 2 EFI Main Harness (PINK) to a source with other components that pull high current, such as the ignition coil, or starter solenoid.**

**WARNING! Disconnect the battery cables before any work is performed to the vehicle.**

# MECHANICAL INSTALLATION INSTRUCTIONS

## SNIPER 2 EFI THROTTLE BODY INSTALLATION

1. Start by labeling all vacuum lines connected to the carburetor for easy identification, i.e. brake booster & vac advance for distributor.
2. Remove the carburetor, clean the gasket mating surface, and install the provided intake flange gasket on the intake manifold.
3. Place the Sniper 2 EFI throttle body on top of the new flange gasket on the manifold. Install the hold down nuts and snug down progressively in a "criss-cross" pattern (60-80 in.lbs.).
  - a. This is also the time to install your throttle bracket and transmission kickdown brackets if applicable.

THROTTLE LINKAGE/BACKET SIDE VIEW

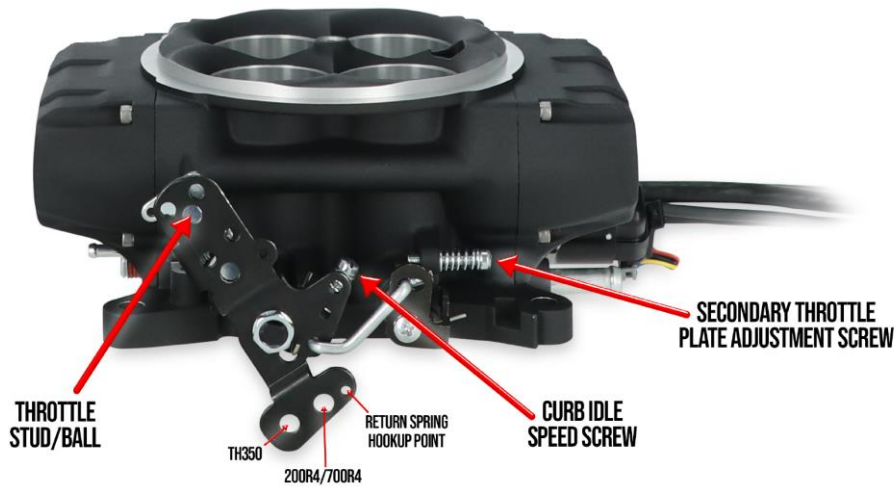

FIGURE 2

4. Reconnect the throttle and transmission kick-down linkage. Be sure to check for any binding conditions and correct before proceeding. Poorly routed throttle cables & linkages can cause throttle pedal issues. See **Figure 2** for correct linkage placement.
5. Reconnect the appropriate vacuum hoses to the Sniper 2 EFI throttle body. **Be sure to plug or cap any vacuum sources not used on both the Sniper 2 EFI Throttle Body and on the Engine.** See **Figure 3** for diagram of vacuum ports.

VACUUM PORT VIEW

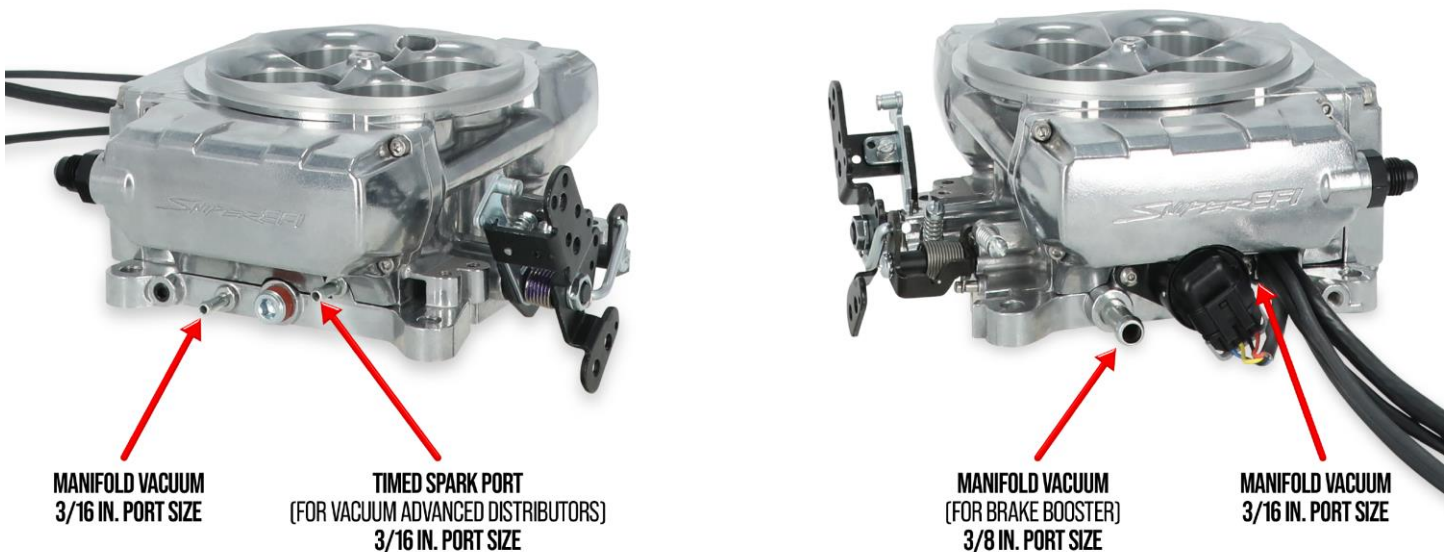

FIGURE 3

6. Connect fuel feed and return hose to the throttle body. The throttle body has a cast in fuel crossover, passing fuel from the front bowl to the rear bowl. Either fitting can be used as inlet or outlet. The inlet fuel should come from the pump through a filter and the **outlet fuel should go to an external regulator set between 55-65 PSI**. We recommend at least a 3/8" feed line and 3/8" return line. See **Figure 4**

**NOTE:** Fuel pressure should be checked at the gauge port on the regulator before initial start up during the fuel pump prime. We recommend Holley Part Number [26-507](#) (0-100 PSI Liquid filled gauge).

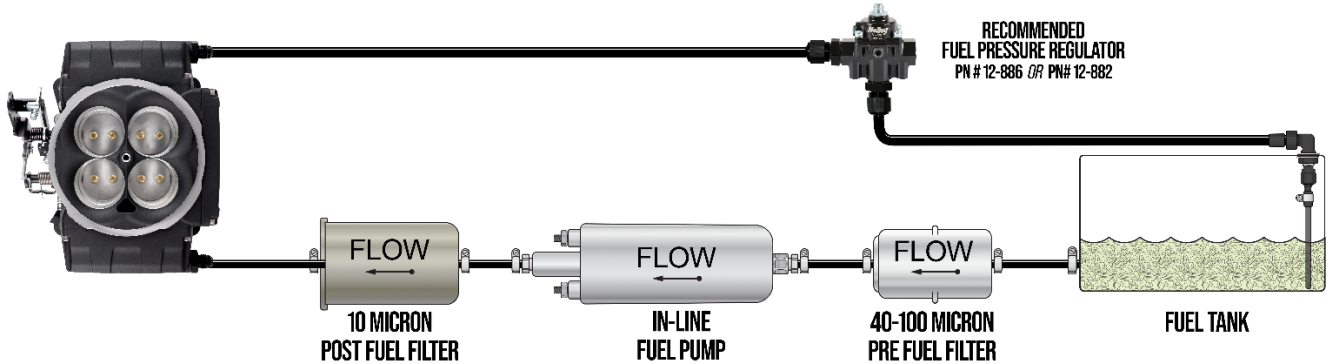

FIGURE 4

## OXYGEN SENSOR INSTALLATION

Locate a position for the oxygen sensor as close to the engine as possible. The oxygen sensor should be mounted at a point where it can read a good average of all the cylinders on one bank. This would be slightly after all the cylinders merge. When using long tube headers, mount the sensor approximately 1-10" after the collector. Sensor must have at least 18" of exhaust pipe after the sensor. Verify that the Oxygen sensor is tight in the bung.

- a. If your vehicle has catalytic converters, the oxygen sensor **MUST** be located between the engine and the catalytic converters.
- b. It is **CRITICAL** that the oxygen sensor is NOT installed in the bottom of the exhaust tube. This will help prevent condensation in the exhaust tubing from entering the sensor. **Figure 5**
- c. The clamp-on kit installation requires a 3/4 hole to be drilled in the exhaust system. Place Gasket and Stainless Investment Cast Bung on the pipe and tighten the clamps.
- d. Ensure there are no potential air leaks around the bung.
- e. Verify that the O2 cable is supported correctly and away from heat sources such as the exhaust. **Damage to the O2 Cable is not covered under warranty.**

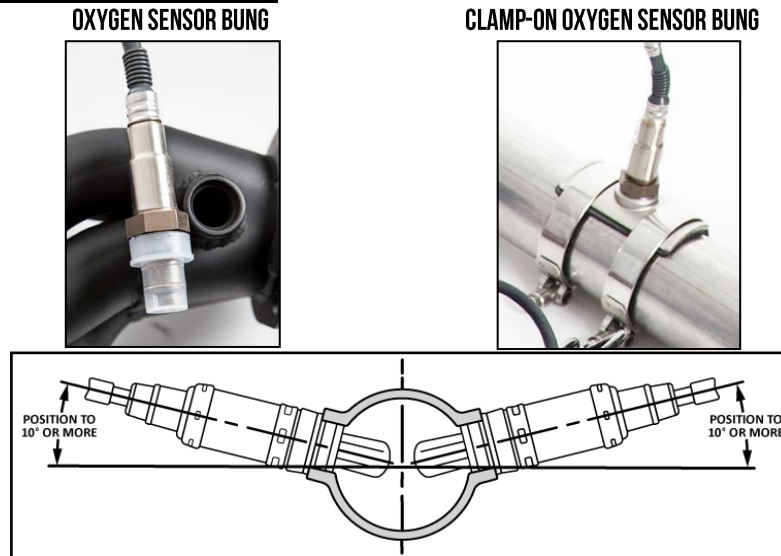

FIGURE 5

## COOLANT TEMP SENSOR INSTALLATION

Install the **Coolant Temperature Sensor** into a 3/8" NPT coolant passage, in either the intake manifold or cylinder head. Do not overtighten or damage to the cylinder head or intake may occur. Use thread sealer or a small amount of thread tape.

# SNIPER 2 EFI WIRING COMPONENT OVERVIEW

## SNIPER 2 EFI THROTTLE BODY CABLES AND CONNECTIONS

- **Large 16 Pin Connector:** Sniper 2 EFI Main Wiring Harness connection
- **User Interface Connector:** M8 Can 1 connection, for the programing user interface
  - 3.5" TSLCD (553-202)
  - 5" TSLCD (553-200)
  - Sniper 2 BLE Module (558-498)
- **Coolant Temp Connector:** Coolant Temp Sensor (CTS) Connection, PN 543-120
- **Oxygen Sensor Connector:** Wide Band Oxygen (WBO2) Sensor Connection, PN 554-155



### SNIPER 2 EFI MAIN CONNECTOR 16 PIN

The following tables outline the functions of each pin in the Sniper 2 EFI Main Connector

**16 Pin Connector:** This connector contains:

Pin	Color	Labeled Name	Function
A	Red	Battery Positive (+)	Connects directly to battery positive terminal
B	Pink	Switched Ignition (+12v)	<b>NOTE: must remain powered during cranking</b>
C	Yellow	Coil (-) Input	Engine Speed Input (see Ignition System Wiring section)
D	Green	Crank Signal Negative (-)	Engine Speed Signal Ground (see Ignition System Wiring section)
E	Green/White Stripe	Output #2 (-)	Optional – Connect to relay ground trigger
F	Orange	TPS Output	Optional – Connect to external Transmission Controller TPS Signal
G	Light Green	Input #1 (-)	Optional - Connect to a ground input
H	Brown	CAN 2 HI	CAN 2 HI for Future Expansion
J	Orange	CAN 2 LO	CAN 2 LO for Future Expansion
K	Gray	Tach Output	Used to drive an aftermarket tachometer
L	Light Blue	Input #2 (-)	Optional - Connect to a ground input
M	Black/Yellow	Output #1 (-)	Optional – Connect to relay ground trigger
N	Purple	Crank Signal Input	Engine Speed Signal Input (see Ignition System Wring Section)
P	White	Points Output	Used to trigger a CD ignition box
R	Blue	Fuel Pump Output (-)	Fuel Pump Ground Output
S	Black	Battery Negative (-)	Connects directly to battery negative terminal

**NOTE:** The ground outputs from the Sniper 2 EFI are rated for 2 Amps and less, they can only be used to trigger a relay on the ground side.

### SNIPER 2 EFI MAIN WIRING HARNESS

The Sniper 2 EFI Eco System contains two different main wiring harnesses:

- **558-190 (271R1314A) (shown on right):** This main harness does NOT have a fuel pump relay & is intended to ground trigger an external fuel pump relay. This harness is shipped with Sniper 2 EFI kits that include a Sniper EFI PDM.
- **558-191 (271R1338A):** This main harness has a fuel pump relay and large gauge wire to power a fuel pump directly. This harness ships with Sniper 2 EFI Kits that were ordered without a Sniper EFI PDM.



## **SNIPER 2 EFI I/O WIRING HARNESS**

### **6 Pin Connector – Mating Harness PN 558-497**

- 6 wire harness used for optional inputs & outputs, as well as Tach Output and TPS output.



<b>Pin</b>	<b>Color</b>	<b>Labeled Name</b>	<b>Function</b>
A	Orange	TPS Output	Optional – Outputs 0-5V signal mimicking the internal TPS signal
B	Black/Yellow	Output #1 (-)	Optional – Connect to ground side of relay trigger (Default Fan 1)
C	Light Blue	Input #2 (-)	Optional – Connect to a programmable ground input
D	Light Green	Input #1 (-)	Optional – Connect to a programmable ground input (Default IAC Kick)
E	Grey	Tach Output	Optional – Used to drive an aftermarket tachometer
F	Green/white	Output #2 (-)	Optional – Connect to ground side of relay trigger (Default Fan 2)

## **SNIPER 2 EFI POWER DISTRIBUTION MODULE (PDM)**

The Sniper 2 EFI Eco System contains an **optional** Sniper EFI Power Distribution Module (554-200).

- The Sniper EFI PDM is intended to make wiring easy and less intimidating.
- The PDM provides an engineered wiring solution to reduce potential issues seen in the field.
- The PDM provides conditioned Power, Ground and Switched Connections for ALL components within a Sniper 2 EFI Install.
  - Throttle Body, Fuel Pump, HyperSpark Ignition System, and **Optional Fan**
- When using the PDM, the number of wires connected to the battery posts and switched 12V source are reduced.
- PDM includes built in Diagnostic LED's to help with troubleshooting

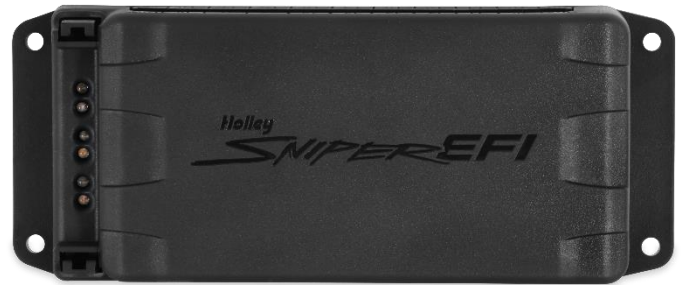

# SNIPER 2 EFI WIRING INSTRUCTIONS

## SNIPER 2 EFI USER INTERFACE

Attach the 3.5" TSLCD (553-202), to the M8 Sniper 2 EFI User Interface cable. The cable ends on the throttle body and the user interface have a keyway and will only connect in one orientation. Once oriented properly, screw the connector together. Route the cable through the firewall, using a grommet to protect the cable from vibration over time.



**Do not connect the 3.5" TSLCD to the M8 on the Sniper 2 Main Harness, as it will not function correctly.**

**NOTE:** The Touch Screen LCD Display does not need to be connected to the Sniper 2 EFI after the calibration wizard has been run. If it is not present, make sure the Sniper 2 User Interface cable is secured where it cannot be damaged.

## SNIPER 2 EFI COOLANT TEMP SENSOR

Connect the Coolant Temp Sensor Cable to the Coolant Temp Sensor (CTS), routing the cable away from hazards such as the throttle linkage or the exhaust

## SNIPER 2 EFI OXYGEN SENSOR

Connect Oxygen Sensor cable coming from the throttle body to the oxygen sensor in the exhaust. Making sure that the cable and wiring is all supported properly and away from hazards

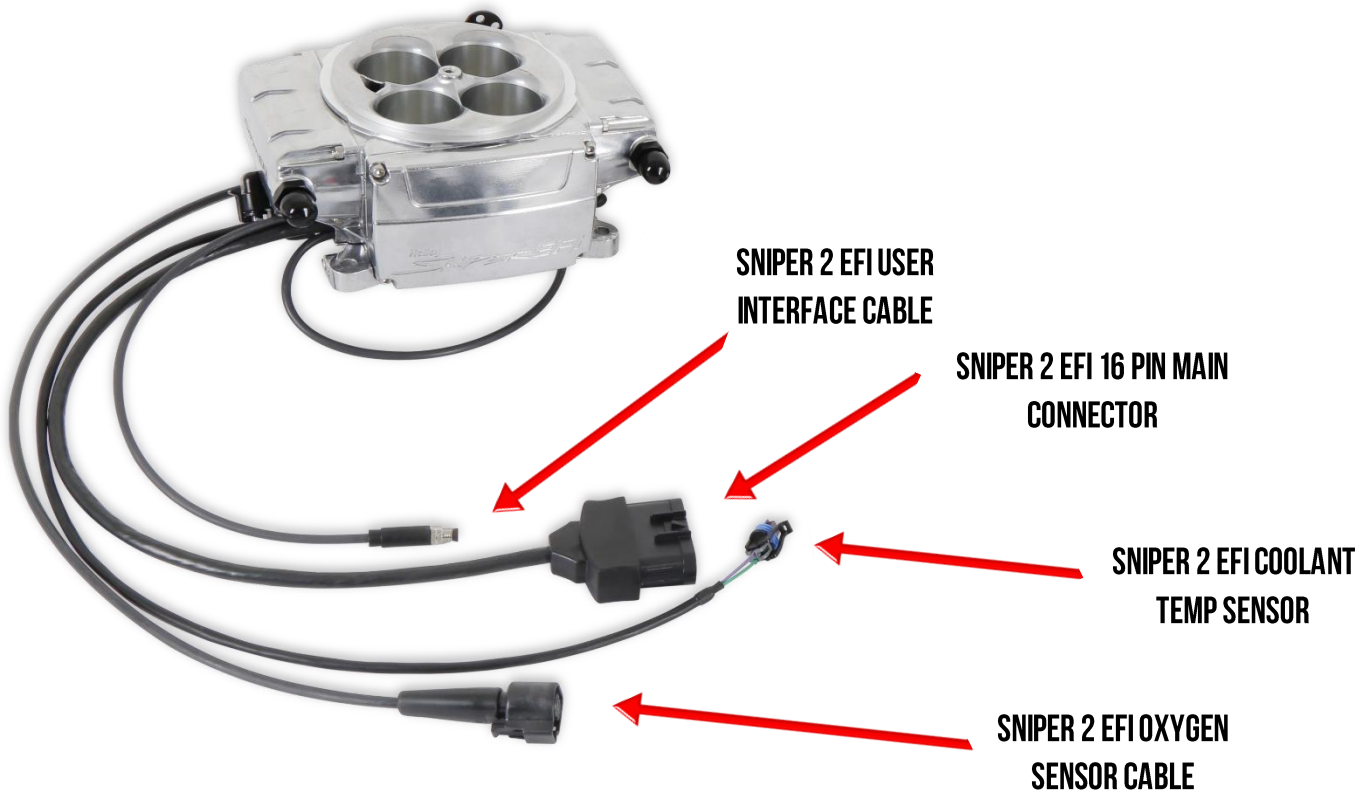



## **SNIPER 2 EFI REQUIRED WIRING CONNECTIONS**

Sniper 2 EFI can be wired and configured where the Sniper 2 EFI controls both the fueling and spark timing for your engine, or it can control just the fueling. The options below are described and have associated wiring diagrams within this QuickStart manual.

- Sniper 2 EFI Fuel Control Only
  - Coil Minus
  - CD Box
- Sniper 2 EFI Fuel and Spark Control
  - HyperSpark distributor and ignition box.

### **SNIPER 2 EFI NON TIMING CONTROL OPTION 1: COIL (-) IGNITION**

Sniper 2 EFI **IS NOT** controlling the Ignition Timing Using **Coil Minus** RPM Signal:

<b><u>Color</u></b>	<b><u>Labeled Name</u></b>	<b><u>Function</u></b>
Red	Battery Positive (+)	Connects to Terminal 5 on PDM <b><u>or</u></b> directly to battery positive
Black	Battery Negative (-)	Connects to Terminal 8 on PDM <b><u>or</u></b> directly to battery negative
Blue	Fuel Pump*	GND Trigger to Terminal 3 PDM <b><u>or</u></b> +12v powering Fuel Pump
Pink	Switched Ignition (+12v)	Connects to Terminal 4 on PDM <b><u>or</u></b> directly to SW 12 Source
Yellow	Coil (-) Input	Engine RPM Input (see Ignition Wiring section)

\*Harnesses without Relay are GND Trigger, Harness with Relay are 12V+

### **SNIPER 2 EFI NON TIMING CONTROL OPTION 2: CAPACITIVE DISCHARGE IGNITION (CD BOX)**

Sniper 2 EFI **IS NOT** controlling the Ignition Timing Using **CD Box** Tach Output:

**Must Purchase Holley Part Number 558-329.** Which plugs into the Ignition Connector 3 pin and terminates at the Tach Output on the Ignition System

<b><u>Color</u></b>	<b><u>Labeled Name</u></b>	<b><u>Function</u></b>
Red	Battery Positive (+)	Connects to Terminal 5 on PDM <b><u>or</u></b> directly to battery positive
Black	Battery Negative (-)	Connects to Terminal 8 on PDM <b><u>or</u></b> directly to battery negative
Blue	Fuel Pump*	GND Trigger to Terminal 3 PDM <b><u>or</u></b> +12v powering Fuel Pump
Pink	Switched Ignition (+12v)	Connects to Terminal 4 on PDM <b><u>or</u></b> directly to SW 12 Source
Yellow	Coil (-) Input	Not Used

\*Harnesses without Relay are GND Trigger, Harness with Relay are 12V+

### **SNIPER 2 EFI TIMING CONTROL OPTION: USING HYPERSPARK DISTRIBUTOR**

Sniper 2 EFI **IS** controlling the Ignition Timing, using a **HyperSpark Distributor** & Ignition System:

<b><u>Color</u></b>	<b><u>Labeled Name</u></b>	<b><u>Function</u></b>
Red	Battery Positive (+)	Connects to Terminal 5 on PDM <b><u>or</u></b> directly to battery positive
Black	Battery Negative (-)	Connects to Terminal 8 on PDM <b><u>or</u></b> directly to battery negative
Blue	Fuel Pump*	GND Trigger to Terminal 3 PDM <b><u>or</u></b> +12v powering Fuel Pump
Pink	Switched Ignition (+12v)	Connects to Terminal 4 on PDM <b><u>or</u></b> directly to SW 12 Source
White	Sniper Points Output	Connects to Terminal 6 on PDM <b><u>or</u></b> to Ignition Box Points Input
	3 Pin Ignition Connector	Connects directly to a Standard HyperSpark Distributor

\*Harnesses without Relay are GND Trigger, Harness with Relay are 12V+

## STEPS TO WIRE SNIPER 2 MAIN HARNESS

- Layout Sniper 2 EFI Main Harness on engine and in the vehicle. The Sniper 2 EFI wiring exits the throttle body from the rear, typically towards a firewall. Secure the harness to the vehicle, leaving access to the fuse in the future.
- Route the 12GA Red and Black wires directly to the **Sniper PDM** or **Directly to the Battery Posts**.
  - Red Connects to Terminal 5 on **Sniper PDM** or **directly to battery positive post**
  - Black Connects to Terminal 8 on **Sniper PDM** or **directly to battery negative post**
- Route the 20GA Pink SW 12V (+) wire to Terminal 4 on the **Sniper PDM** or to the **12V switched ignition source**.
- Fuel Pump Wire
  - Main Harness without a relay (558-190)**, connect the 20 GA blue wire to terminal 3 on the Sniper PDM
  - Main Harness with a relay (558-191)**, route the wire to the fuel pump and properly secure and protect the wire from any potential hazards. Then connect the 14GA blue wire to the positive side of the Fuel Pump and connect the negative side of the fuel pump to a good chassis ground.
- Wire the ignition system according to Ignition System Wiring Section that matches your installation.
  - Non Timing Control Option 1:** Coil Minus (Yellow wire)
  - Non Timing Control Option 2:** CD Box (558-329 Adapter Harness)
  - Timing Control Option using HyperSpark Distributor:** HyperSpark Distributor and CD Box.
- Tie up or shorten all wires unused, making sure to put heat shrink over the ends of any unused wiring, so they cannot contact anything in or on the vehicle.

## IGNITION SYSTEM WIRING

### NON TIMING CONTROL OPTION 1: COIL (-) IGNITION

Locate the YELLOW wire on the Sniper 2 Main Harness. This wire can either go to the NEGATIVE side of your ignition coil, or to "Tach" label on a GM Large Cap HEI distributor w/ internal coil. **NEVER** run the YELLOW wire to the negative side of a coil while using a CD Ignition box.

### COIL (-)

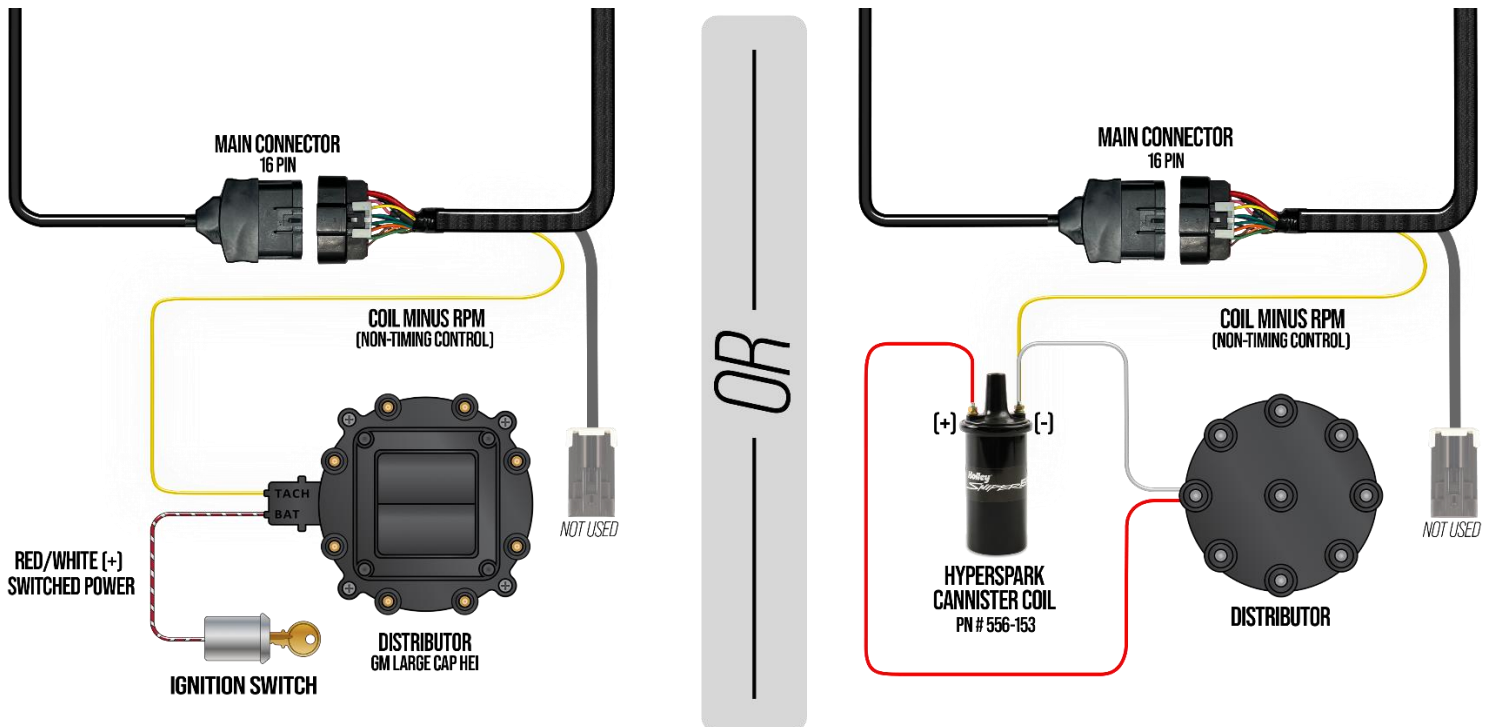

**OR**

## **NON TIMING CONTROL OPTION 2: CAPACITIVE DISCHARGE IGNITION (CD BOX)**

**Must Purchase Holley Part Number 558-329.** The 3 Pin connector plugs into to the Ignition Connector on the Sniper 2 Main Harness. The loose end of the PURPLE wire will then be terminated to the tach output wire on the CD Box. On an MSD 6AL (shown below) this wire is GREY. Refer to the ignition box instructions for more information on the tach output wiring. When using an aftermarket ignition box, **NEVER connect the PURPLE wire to the ignition coil!**

**NOTE:** If ignition box or distributor has ability to send rpm signals with initial key on (such as a Tach Sweep or Rev Limiter Verification), these settings must be disabled. Reference ignition system instructions.

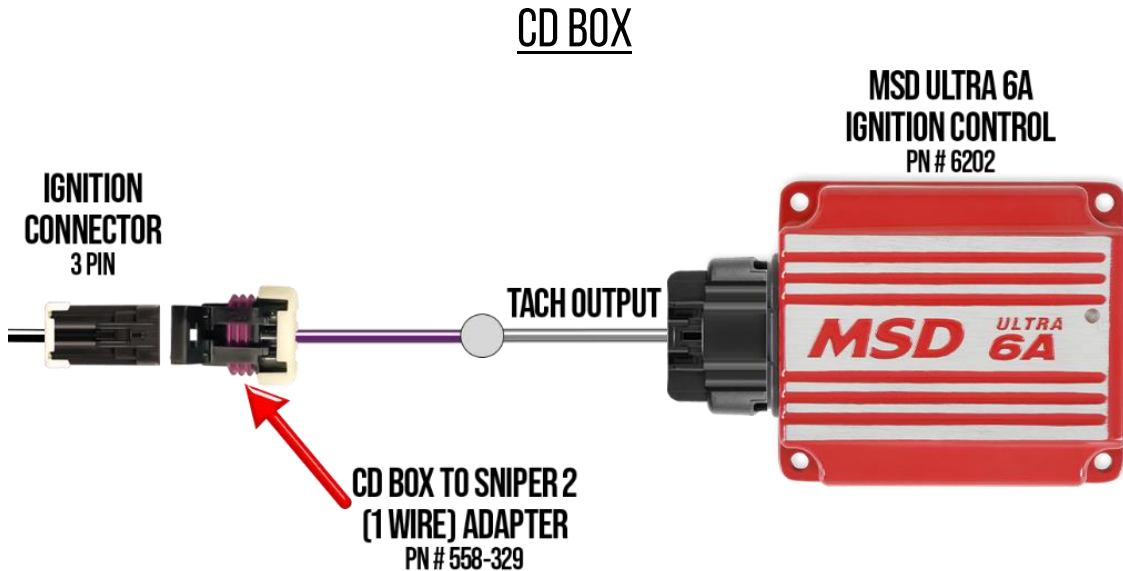

**CAUTION! NEVER connect any of the EFI wires to the coil on any CD type ignition system. The ECU will be permanently damaged!**

## **TIMING CONTROL OPTION: HYPERSPARK DISTRIBUTOR & IGNITION SYSTEM**

**HyperSpark Distributor:** The Sniper 2 EFI Main Harness has a 3 Pin Ignition Connector. This connector directly plugs into a Standard HyperSpark Distributor, and provides the distributor Switched Power, Ground and connects the signal wire from the Distributor to the Sniper 2 ECU. Install the distributor into the engine using the [HyperSpark Distributor Instructions](#). Since the Sniper 2 EFI Main harness is plug and play with a Standard HyperSpark Distributor, the mechanical installation process is all that needs to be followed (Steps 1-7) within the distributor instructions.

Once the distributor is installed in the engine, simply plug the distributor 3 pin connector into the Sniper 2 EFI Main Harness Ignition Connector.

**Ignition Box:** Install the Ignition Box according to the manufacturer's instructions. The Sniper 2 EFI will trigger the ignition box using the Sniper 2 Points Output (white wire) within the Sniper 2 EFI Main Harness. Connect the white wire to the Ignition box trigger wire. This wire is normally white on most aftermarket Ignition boxes, but verify with the manufacturer's instructions.

**Coil:** Install the ignition coil per the manufacturer's instructions.

**See wiring full wiring diagrams on the last pages of this manual:**

**DIAGRAM 1: COIL MINUS (-) [ NO TIMING CONTROL ]**

**DIAGRAM 2: SNIPER 2 ECO SYSTEM USING A SNIPER EFI PDM**

**DIAGRAM 3: SNIPER 2 ECO SYSTEM WITHOUT USING A SNIPER EFI PDM**

## OPTIONAL FAN CONTROL WITH SNIPER 2 EFI

When using the Calibration Wizard to create the Sniper 2 EFI calibration, Fan 1 and Fan 2, are programmed as such:

Fan 1 programmed to Output #1 (Black with Yellow Stripe)

Fan 2 programmed to Output #2 (Green with White Stripe)

In the Sniper 2 EFI User Interface (3.5" TSLCD, 5" TSLCD, Sniper EFI App using BLE Module) change the desired temperature at which you want the fan(s) to turn on and off at, **by default these temperatures are not set.**

Sniper 2 EFI is able to detect if there is a load on the output wiring corresponding with the programmable output. If the temperature threshold is met, but there is no fan wired, it is wired incorrectly or there is a problem with the relay triggering the fan, an "Open!" will show on the user interface when looking at the Fan Status.

### FAN WIRING USING A SNIPER EFI PDM

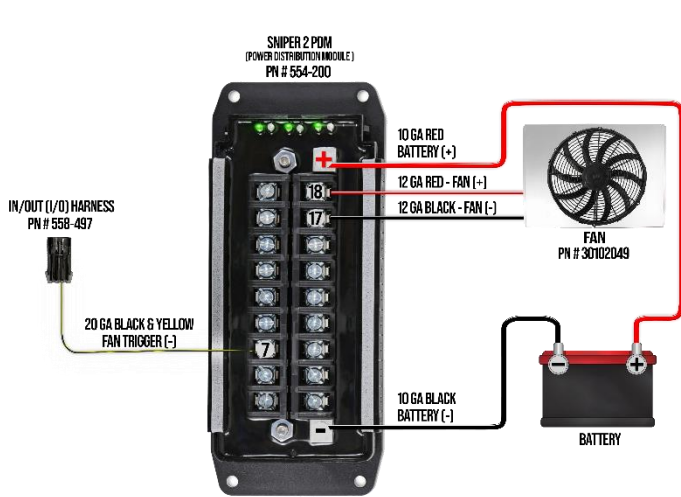

### FAN WIRING USING MSD 7566-1 RELAY

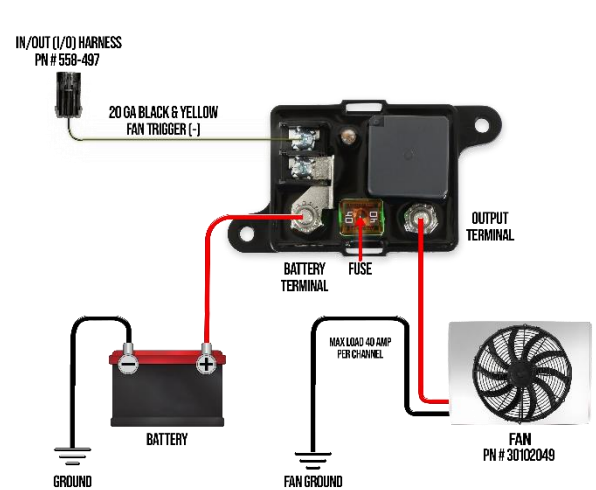

## INITIAL POWER-UP & WIZARD

Turn the ignition key to the "run" position. If wired properly the Sniper 2 EFI will power the Sniper 2 EFI User Interface. When using a 3.5" TSLCD, the Home Screen should appear. The fuel pump will not turn on without running a Calibration Wizard.

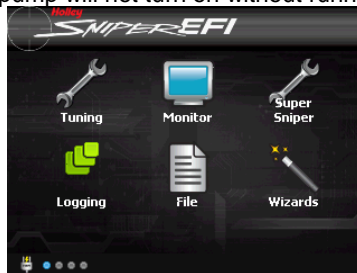





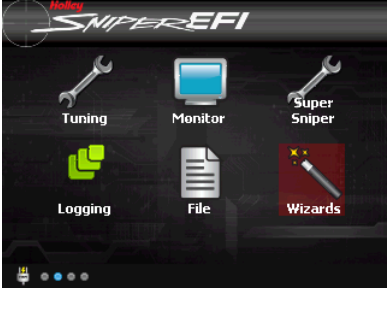
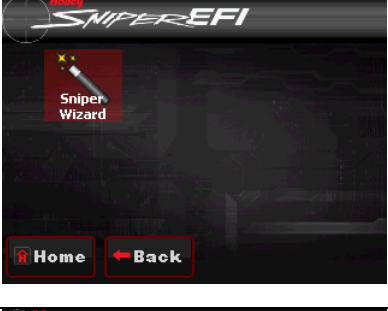
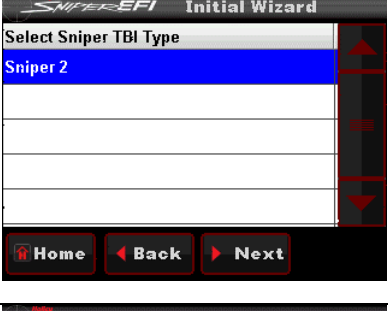
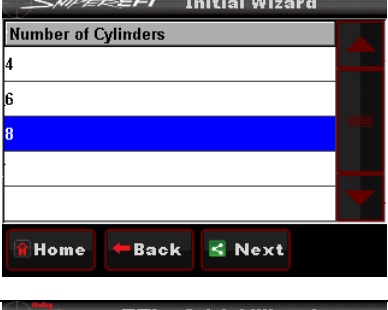
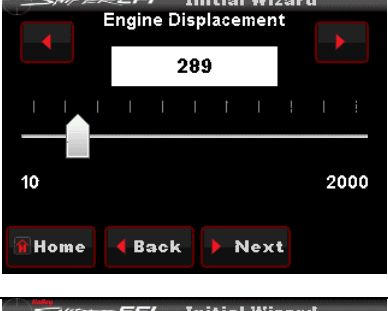
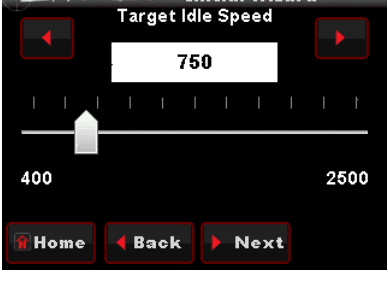

The Sniper EFI Home screen contains icons which will navigate to different functional features of the Touch Screen.

## CALIBRATION WIZARD

**NOTE:** DO NOT ATTEMPT TO START THE VEHICLE UNTIL YOU ARE TOLD TO DO SO IN THE INSTRUCTIONS BELOW.

**NOTE:** The 3.5" TSLCD has an SD memory card installed in the side. This card contains specific information that is required for the use of the Sniper EFI product.

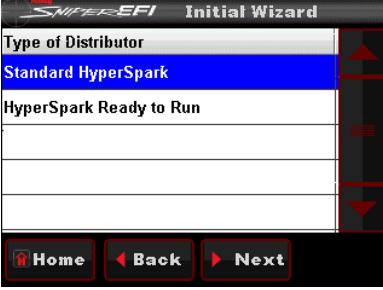
<p><b>STEP 1</b></p>		<p>Select <b>Wizards</b> from the main menu</p>
<p><b>STEP 2</b></p>		<p>Select the <b>Sniper Wizard</b></p>
<p><b>STEP 3</b></p>		<p>Select your Sniper system type</p> <p><b>Press Next</b></p>
<p><b>STEP 3</b></p>		<p>Select the number of cylinders your engine has</p> <p><b>Press Next</b></p>
<p><b>STEP 4</b></p>		<p>Enter the displacement of your engine, using the slider bar or by pressing the white box.</p> <p><b>Press Next</b></p>
<p><b>STEP 5</b></p>		<p>Set your desired HOT idle speed, using the slider bar or by pressing the white box. This is the RPM the Sniper 2 EFI will target at coolant temperatures above 160 °F</p> <p><b>Press Next</b></p>

<p><b>STEP 6</b></p>		<p>Select your camshaft type:</p> <ul style="list-style-type: none"> <li>• Stock/Mild = This selection will work well on most applications equipped with stock or "street performance" camshafts. Choose Stock/Mild If you are unsure of your camshaft specs</li> <li>• Street/Strip = Select this if your engine has between 8" and 13" of manifold vacuum</li> <li>• Race = Select this if your engine has less than 7" of manifold vacuum. Race oriented camshafts may require laptop tuning for optimal idle stability</li> </ul> <p><b>Press Next</b></p>
<p><b>STEP 7</b></p>		<p>Select your engines power adder type, the wizard can build a boosted base calibration for 650 HP or less</p> <ul style="list-style-type: none"> <li>• None</li> <li>• Turbo</li> <li>• Supercharger</li> </ul> <p><b>Press Next</b></p>
<p><b>STEP 8</b></p>		<p>Select your ignition type, Methods covered by this Quick Start Guide are:</p> <ul style="list-style-type: none"> <li>• Coil (-) [no timing control]</li> <li>• CD Ignition Box [no timing control]</li> <li>• HyperSpark Distributor [timing control]</li> </ul> <p><b>Press Next</b></p>
<p><b>STEP 8 continued</b></p>		<p>If HyperSpark Distributor is selected in Step 8, please clarify if it is a:</p> <ul style="list-style-type: none"> <li>• Standard HyperSpark</li> <li>• HyperSpark Ready to Run</li> </ul> <p><b>Press Next</b></p>
<p><b>STEP 9</b></p>		<p>If a non timing control method was chosen in Step 8, skip to step 10</p> <p>If a timing control method was chosen in Step 8, then please enter the amount of Ignition Timing desired at Wide Open Throttle, using the slider bar or by pressing the white box.</p> <p>*Boosted Applications (Turbo &amp; Supercharged) will ask questions regarding AFR and Ignition timing at different boost levels</p> <p><b>Press Next</b></p>
<p><b>STEP 10</b></p>		<p>After answering all questions in the Wizard, your calibration will be created.</p> <p><b>Press the "Start" icon to send the calibration to the ECU. Once this process is completed, you will see a screen indicating the file has been uploaded. Once file is uploaded, the ignition switch needs to be cycled.</b></p>

## INITIAL POWER-UP

### SENSOR VERIFICATION

Before starting the vehicle, verify that all of the sensors are reading properly. Once the ignition has been cycled after running the Calibration Wizard, you should hear the fuel pump come on and run for 5 seconds.

**Fuel Prime occurs 2.5 seconds after key-on (which is also the amount of time it takes for the touch screen to load). If you quickly turn the ignition key without waiting for the full 2.5 seconds, the prime will not occur and it may take longer for the engine to start.**

**Caution! Multiple key cycles without firing the engine could potentially cause a flooded condition. If ignition box or distributor has ability to send rpm signals with initial key on (such as Tach Sweep or Rev Limiter Verification), these settings must be disabled. Reference ignition system instructions.**

**NOTE:** This is a great time to check for fuel leaks and verify fuel pressure.

From the HOME SCREEN, select the "Monitor" icon, then select the "Monitors" screen. You will see an icon named "Initial Start Up". Select this. With the key on and the engine off, these sensors should read as follows:

- **Engine RPM** – This gauge should show "Stall", once you begin cranking the engine it will show actual engine RPM
- **TPS** (Throttle Position Sensor) – Should read 0. Slowly depress the throttle to wide open. It should read between 85 and 100% at wide open throttle. If it does not, please verify your throttle linkage is allowing full travel of the throttle arm.
- **MAP** (Manifold Air Pressure Sensor) – Should read from 95-102. At high elevations it could read as low as 75.
- **CTS** (Coolant Temperature Sensor) – reads engine temperature.
- **IAC Position** – See Idle Setting/Throttle Plate Setting section in this manual.
- **Battery** – Will read battery voltage. Should be 12.0 volts minimum.



Initial Startup Screen

If ANY of these sensors are not reading properly, the underlying issue must be resolved before the engine is started.

### PRE-STARTUP CHECKLIST

Before starting the engine, double check for leaks, proper wire routing, any wiring hazards or loose nuts and bolts. This is a great time to visually inspect the overall Sniper 2 EFI install.

- Verify Wiring - ECU must be powered and grounded to a Sniper EFI PDM or directly at the battery and the battery is fully charged.
  - o Pink Wire must be attached to a 12V+ switched source that has voltage during cranking and run positions of the ignition switch. Verify this source with a multimeter.
- Handheld powers up
- Wizard has been run with correct Ignition setup chosen
- Fuel pressure has been verified at the Sniper 2 EFI throttle body and is between 55 & 65 psi
- All wiring has been tied away from potential hazards such as the exhaust, fans, pulleys, spark plug wires, 12 Volt accessory wires, the ignition coil and ignition coil wiring.
  - o Pay specific attention to the O2 sensor cable lead. Make sure that it is tied out of the way from any heat sources or other hazards. **Damage to the O2 Cable is not covered under warranty.**

## **STARTUP**

With the handheld still on the “Initial Start Up” screen, crank the engine and look at the RPM parameter. It should change to “Syncng”, indicating the ECU is syncing with the RPM signal for an instant, then show an RPM signal. The engine should fire and run and come to an idle.

If the engine does not start please use the flow chart in the Sniper EFI Troubleshooting Guide on [www.holley.com](http://www.holley.com). If the issue still continues, call Holley Tech service for advice.

If the engine starts but is idling too low and appears to be struggling for air, you may have to open the throttle body idle speed screw at this time. A loud whistling may be experienced at idle if the throttle blades need be opened further.

## **IDLE SETTING/ THROTTLE PLATE SETTING**

Once the engine is up to operating temperature (above 160° F), the idle speed can be set to what was configured in the Wizard. To do this, open up the Initial Startup gauge screen. With the vehicle in neutral, adjust the idle screw on the primary shaft until the IAC Position reads between 2% and 10%. While adjusting the throttle plate screw, watch the TPS value and make sure it stays at 0%. **While adjusting the throttle plate screw, the TPS position may begin to read higher than 0%. If this happens cycling the ignition switch will recalibrate the TPS back to zero.**

**Tech Tip:** If the IAC percentage is reading 0% but the engine is idling higher than programmed idle speed, the throttle plates need to be closed (counter-clockwise on primary throttle screw). On the other hand, if the IAC percentage is at 100%, and the engine is lower or maintaining the programmed idle speed, the throttle plates will need to be opened (clockwise on primary throttle screw).

**NOTE: Do not attempt to set the target idle speed and IAC position until the engine is above 160°F!**

## **AFTER STARTUP**

Once the vehicle has started, double check for any fuel or coolant leaks. Let the vehicle warm up and look at some other parameters to make sure everything is operating properly. Determine if Closed Loop is working and once the engine is warmed up and above 160 degree Coolant Temp, that learn is functioning. Click the “Monitor” Icon, then the “Multi Gauge”, and select the “Air/Fuel Ratio” Icon.

- **AFR, A/F** – This will show the air/fuel ratio the wideband oxygen sensor is reading. The Closed Loop Compensation should be adding or subtracting fuel all the time such that the AFR should always be close to the Target AFR value.
- **Target Air/Fuel Ratio** – This is the target AFR (air/fuel ratio) the ECU is trying to maintain. This will vary depending on the engine speed and load and coolant temperature.
- **Coolant Enr, %:** Indicates the amount of enrichment based on the coolant temperature. 100% is zero enrichment and will not reach this point until the engine is 160 Degree F. Engine will not go into learn mode until this is at 100%.
- **CL Status** – Indicates whether the engine is “Closed Loop” or “Open Loop”. Closed Loop indicates that the ECU is adding or subtracting fuel to maintain the target air/fuel ratio. The Sniper EFI calibrations are such that the system should be operating closed loop almost all of the time.
- **Learn Status** – This indicates the status of the Sniper 2 EFI “Self Tuning” operation (Learn Status). The system will populate the learn table as you drive around. There are several conditions that must occur in order for the Self Tuning to occur. The engine temperature must exceed 160° F. The system must be operating in a closed loop mode, and the Self Tuning must be enabled. The base Sniper EFI calibrations have the Self Tuning enabled. Once the engine coolant temp reaches 160° F, the Self Tuning should be active. The Learn Stat will show “NoLearn” when Self Tuning is not active and “Learn” if Self-tuning is active.
- **INJ PW, msec** – This is the injector pulse width the ecu is commanding to the fuel injector to be open or “flowing” fuel. Low values are less fuel and higher values are more fuel.
- **RPM, rpm** – Indicates the frequency that the engine is running at.
- **Fuel Flow, lb/hr** – Indicates the amount of fuel being injected into the engine at any given time. This will vary depending on the engine speed and load.

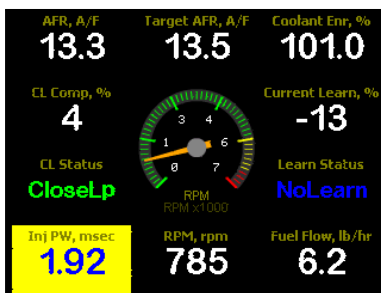

AIR/FUEL RATIO Multi-Gauge  
Engine below 160° F (NoLearn)

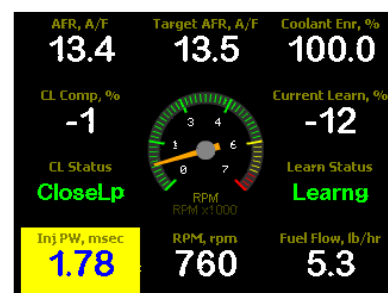

AIR/FUEL RATIO Multi-Gauge  
Engine above 160° F (Learn)



# **FIRST DRIVE**

Congratulations on a successful installation of your Sniper 2 EFI system!

Next, you need to simply drive your car and let the Sniper's self-tuning occur. Learn Percentage is not a progress bar, but rather a value of how much correction to the base fuel table is occurring, to match your specific engine's requirements.

It is best to drive in an area where you can drive under different conditions.

It's always a good idea to have a passenger present to look at things like coolant temperatures, battery voltage, etc, on the first drive.

Start the car and get the engine up to operating temperature (coolant temperature over 160 degrees F) so that the self-tuning can occur. If you'd like, have a passenger look at the handheld display and look at the "CI Comp" value. Once this value is close to zero, the self-tuning process has been completed in that engine operating area. Next, put the car into gear if it's an automatic and let it run there. If the vehicle has air conditioning, you can turn it on, which will put the engine in a different tuning area as well.

Next, slowly accelerate from a stop. If the transmission is a manual, do some slow clutch engagements away from a stop. Then cruise the vehicle at a steady speed, varying the speeds after a few minutes of steady driving. You can also drive in different gears. What you are trying to do is run the vehicle at different engine speed and loads.

After driving under various driving conditions, you can perform some harder acceleration runs including wide open throttle (WOT) runs.

Once completing a handful of drive cycles in various conditions, the Sniper 2 EFI will have performed most of the self-tuning required for a good running engine. As closed loop percentage trends towards 0% in all driving conditions, the Sniper 2 EFI has learned enough to transfer the learn table to the base fuel table and lower the Learn Comp Limits. Again, Learn Percentage is not a progress bar, and after a handful of drive cycle, a value of -35% to 35% is normal depending on the application.

Just performing routine driving will accomplish the learning process. After the engine is up and running and has some drive time on it, minor tuning refinements can be performed to optimize fuel economy and power by the user.

## **CONSIDERATIONS AFTER DRIVING**

After enjoying your Sniper 2 EFI equipped vehicle, it is recommended to transfer the fuel learn to the base fuel table then decrease the percentage of closed loop and learn that the Sniper 2 EFI can utilize.

Transfer the fuel learn table to the base fuel table by Selecting the "Tuning" Icon, then "Advanced", then "Adv. Learn", and press the "Transfer table" selection. It will ask if you want to smooth the base fuel table after transferring the values. It is recommended to smooth the table when transferring.

Start by watching Closed Loop % on your user interface. Verify it has trended towards zero in all driving situations. Once verified that Closed Loop does not ever show lower than -20% or higher than 20%, change the limits of Closed Loop Compensation limits to +/-20%. At this time, it is also recommended to lower the Learn Percentage limits down to +/-10%.

**Closed Loop Limit:** Press "Tuning" Icon, then "Advanced", then "Closed Loop", then change the parameter called "Closed Loop Limit".

**Learn comp limits:** Press "Tuning" Icon, then "Advanced", then "Adv. Learn", then change the parameter called "Learn Comp Limits".

What this does: Ensures the self learning within the Sniper 2 EFI system does not learn poor values, such as when an exhaust leak develops, mechanical engine issue develops, or a sensor fails. If something does happen, the modified calibration with restricted Closed Loop and Learn limits, will still allow you to make it home.

It is also recommended to download the calibration and save it to the user interface's SD Card (3.5" TSLCD or 5" TSLCD) once the vehicle drives to your standards. Calibrations can be saved by a user with a unique name. If an issue arises, a previously downloaded calibration from the ECU can be uploaded for diagnostics purposes or even to just get the vehicle home. These calibrations can also be viewed and modified using the Optional Sniper EFI PC software if a user so chooses to.

When running the Calibration Wizard, the initial base calibration created will be saved on the SD Card. However no learn data or changes made from a user interface will be reflected in that base calibration. The ECU calibration which runs the engine does not automatically update the calibration saved on the handheld. To save the most recent ECU calibration, simply "download" from ECU.

**Saving a Calibration:** Press "File" Icon, then "Sniper EFI Configs", then the "Download from ECU".

# SYSTEM INSTALLATION OVERVIEWS

**DIAGRAM 1: SNIPER 2 EFI COIL MINUS (-) [ NO TIMING CONTROL ]**

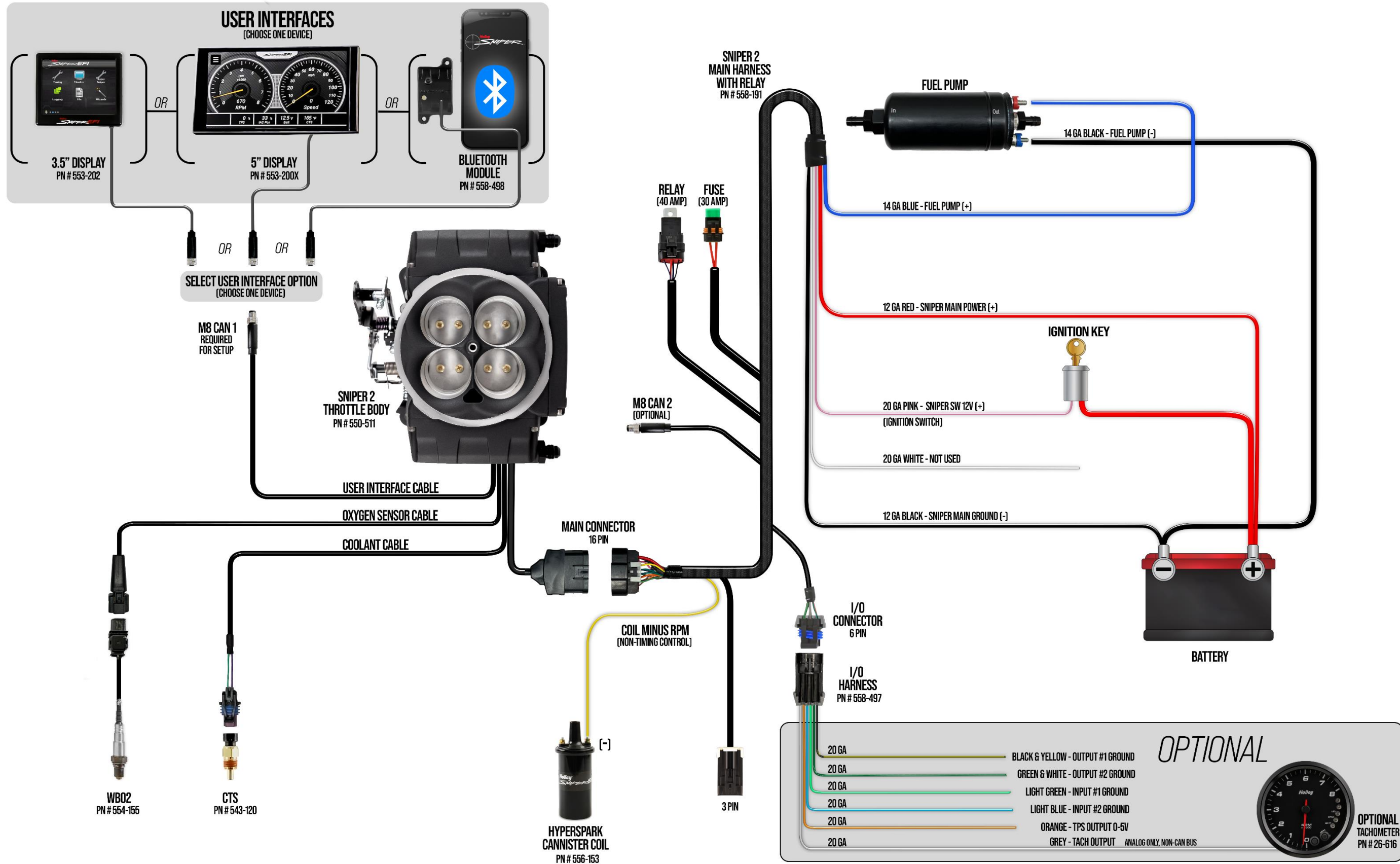

**DIAGRAM 2: SNIPER 2 ECO SYSTEM USING A SNIPER EFI PDM**

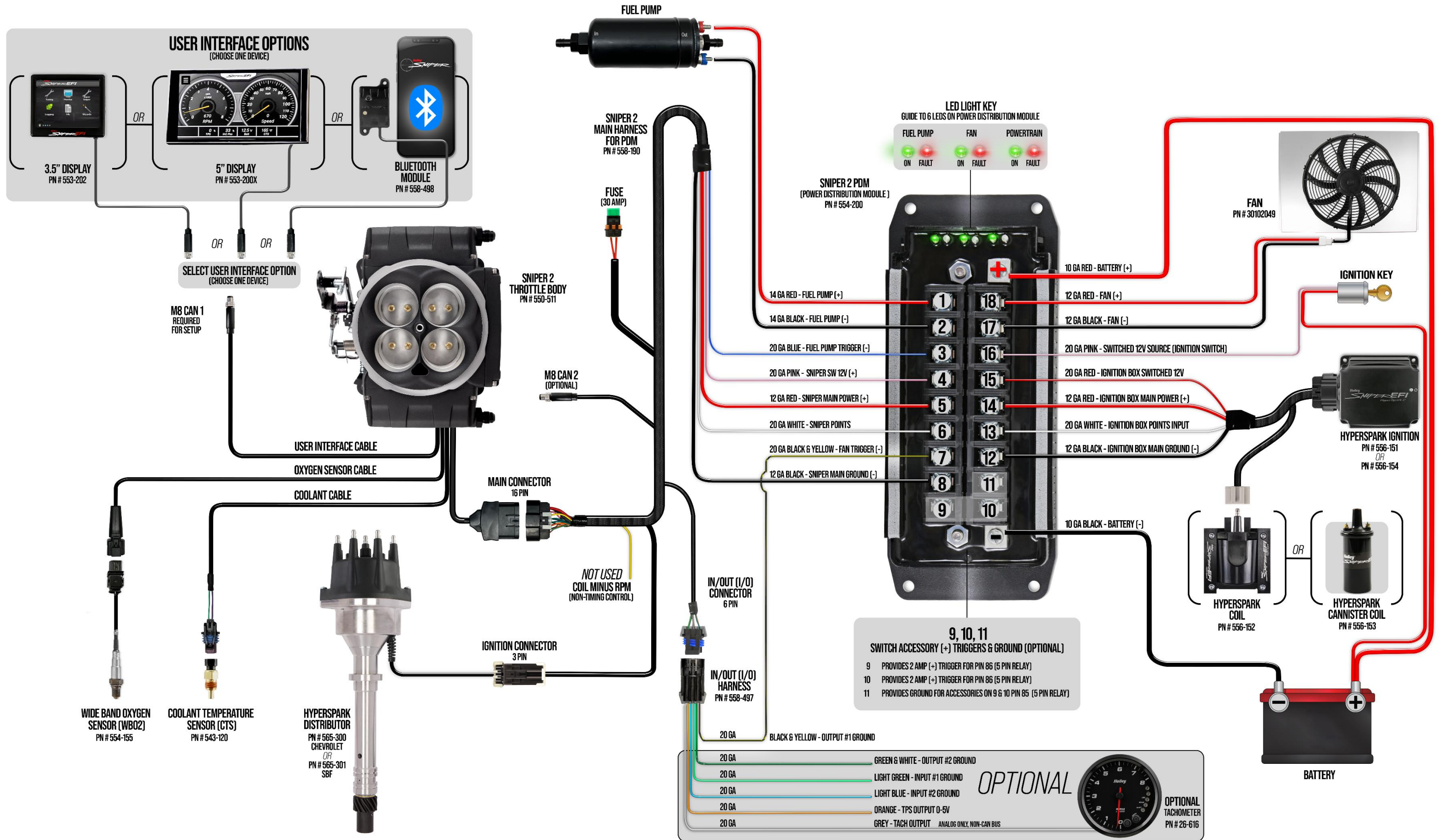

**DIAGRAM 3: SNIPER 2 ECO SYSTEM WITHOUT USING A SNIPER EFI PDM**

